

FARMERS MARKET MATH

K
Kindergarten

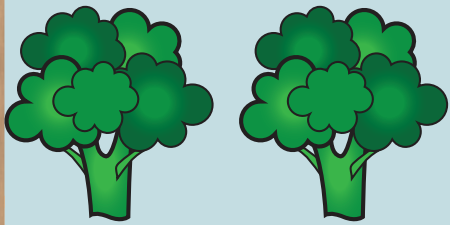

Four

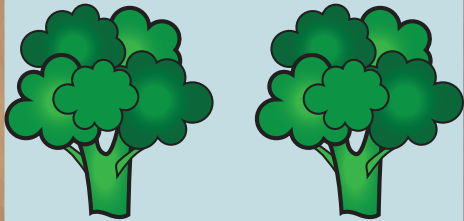

75 ¢
each

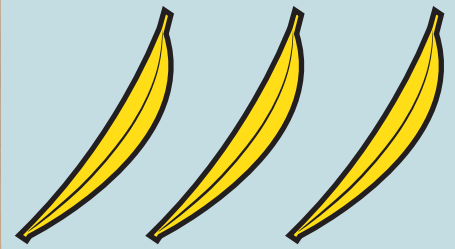
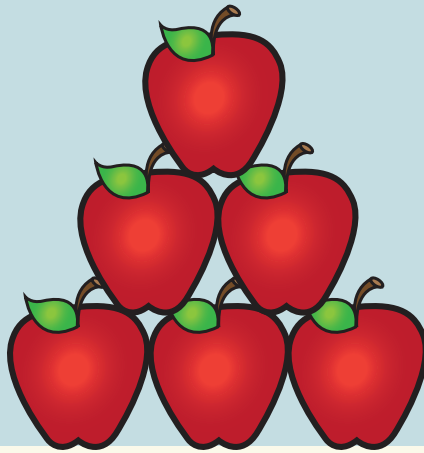

+

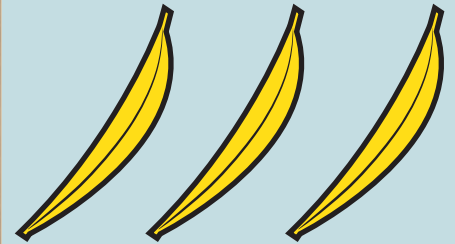

Broccoli

Apples

Bananas

Table of Contents

Farmers Market Math

Cut and Play Farmers Market
Farmers Market Map
Matching Numbers to Quantity
Memory Match Game
Fruit and Veggie Board Game
Market Graphing
Help the Farmer
Fact Families
Using Money
Match Numbers and Words
Addition and Subtraction
Market Riddles

Certificate of Completion

Want more workbooks? Join Education.com Plus to save time and money.
<http://www.education.com/education-plus/>

Cut and Play Farmers Market

Directions: Cut out the play foods and use them to make your own farmers market! What's your favorite item to buy?

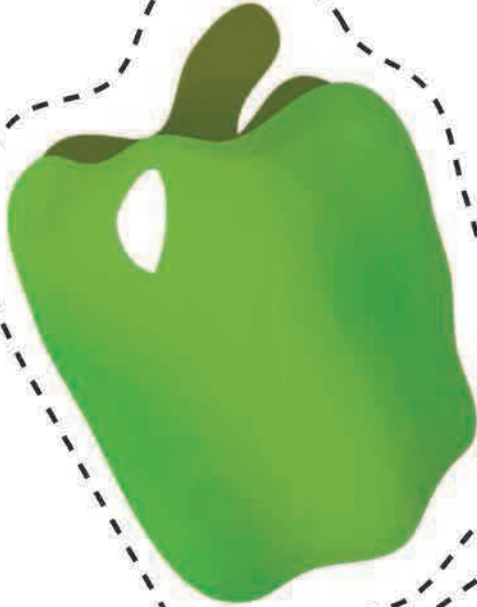

bell pepper

fresh fish

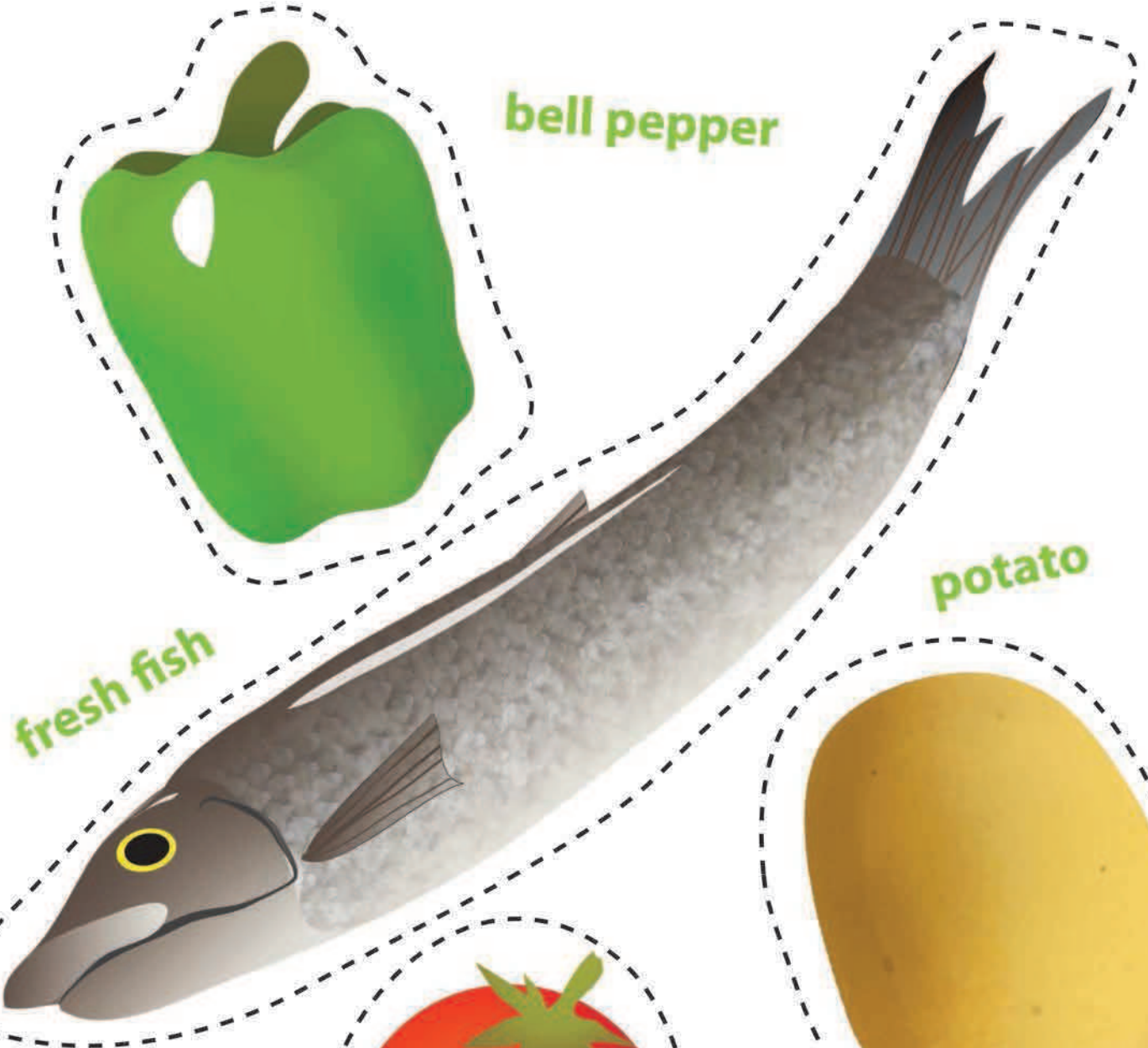

potato

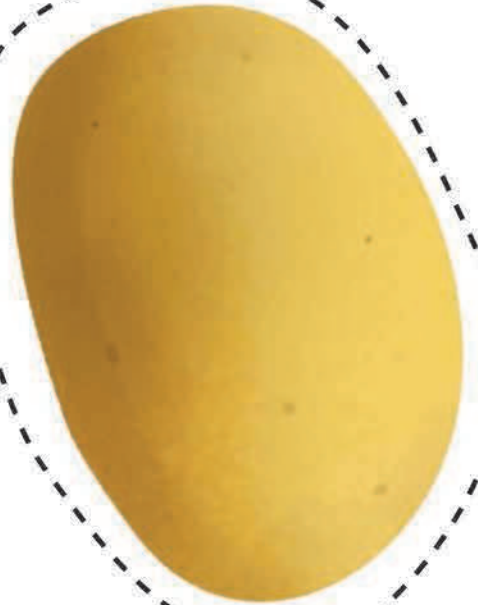

tomato

Cut and Play Farmers Market

Directions: Cut out the play foods and use them to make your own farmers market! What's your favorite item to buy?

mushroom

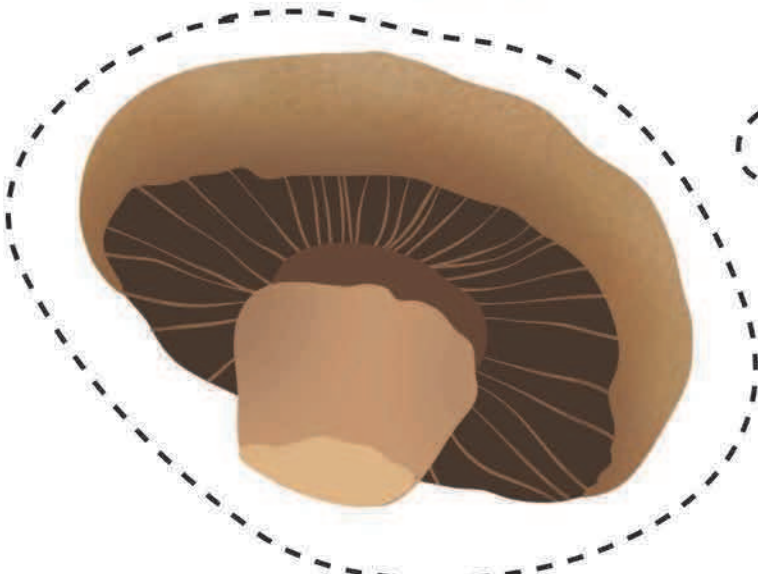

peas

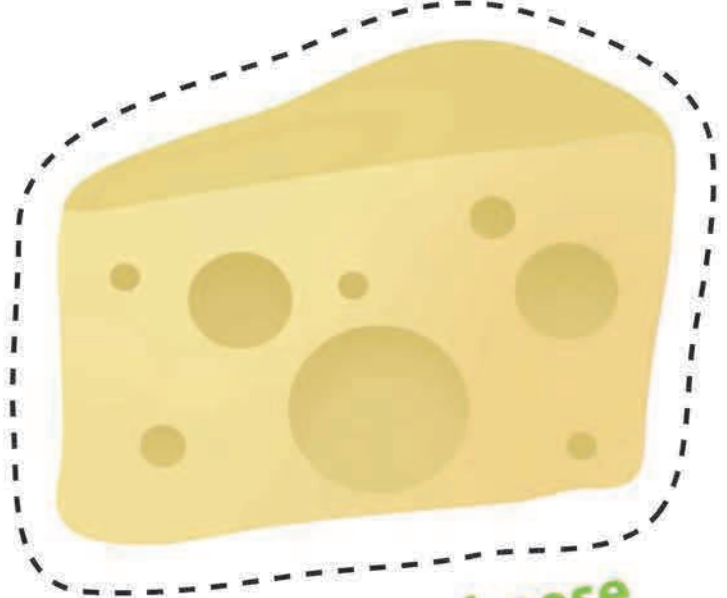
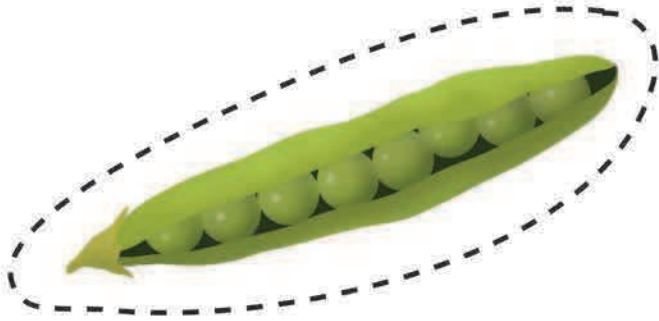
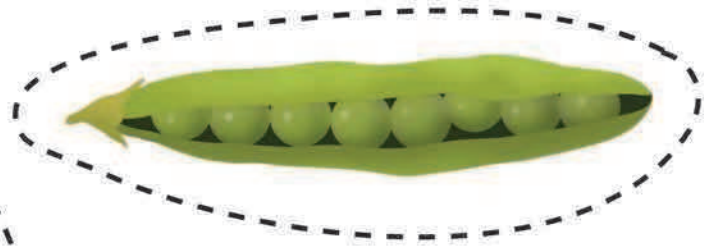

cheese

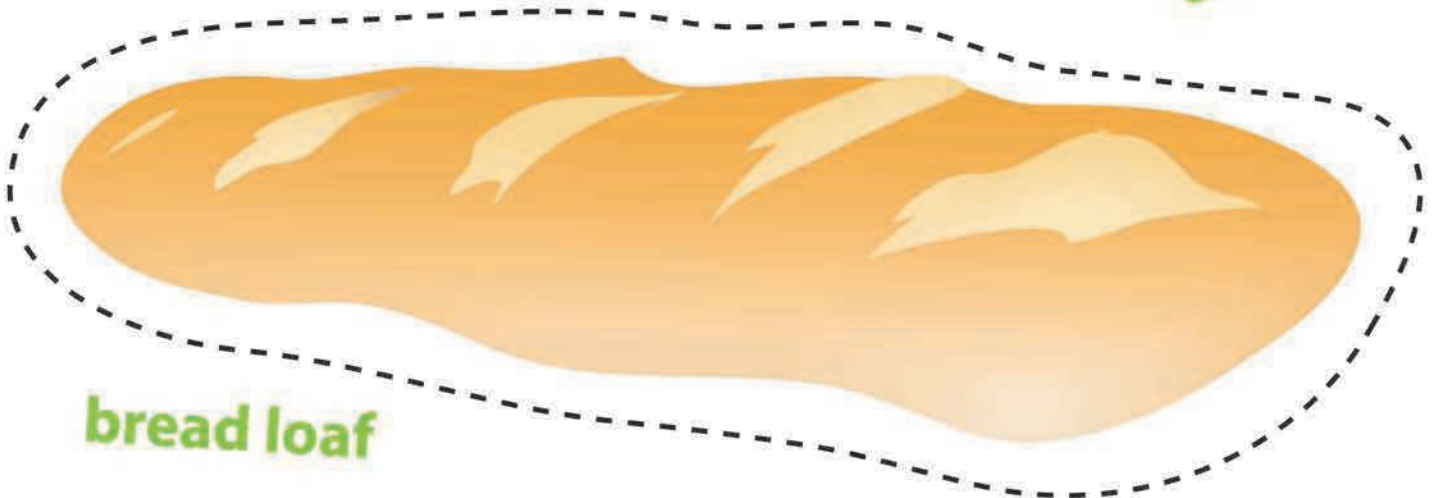

bread loaf

Cut and Play Farmers Market

Directions: Cut out the play foods and use them to make your own farmers market! What's your favorite item to buy?

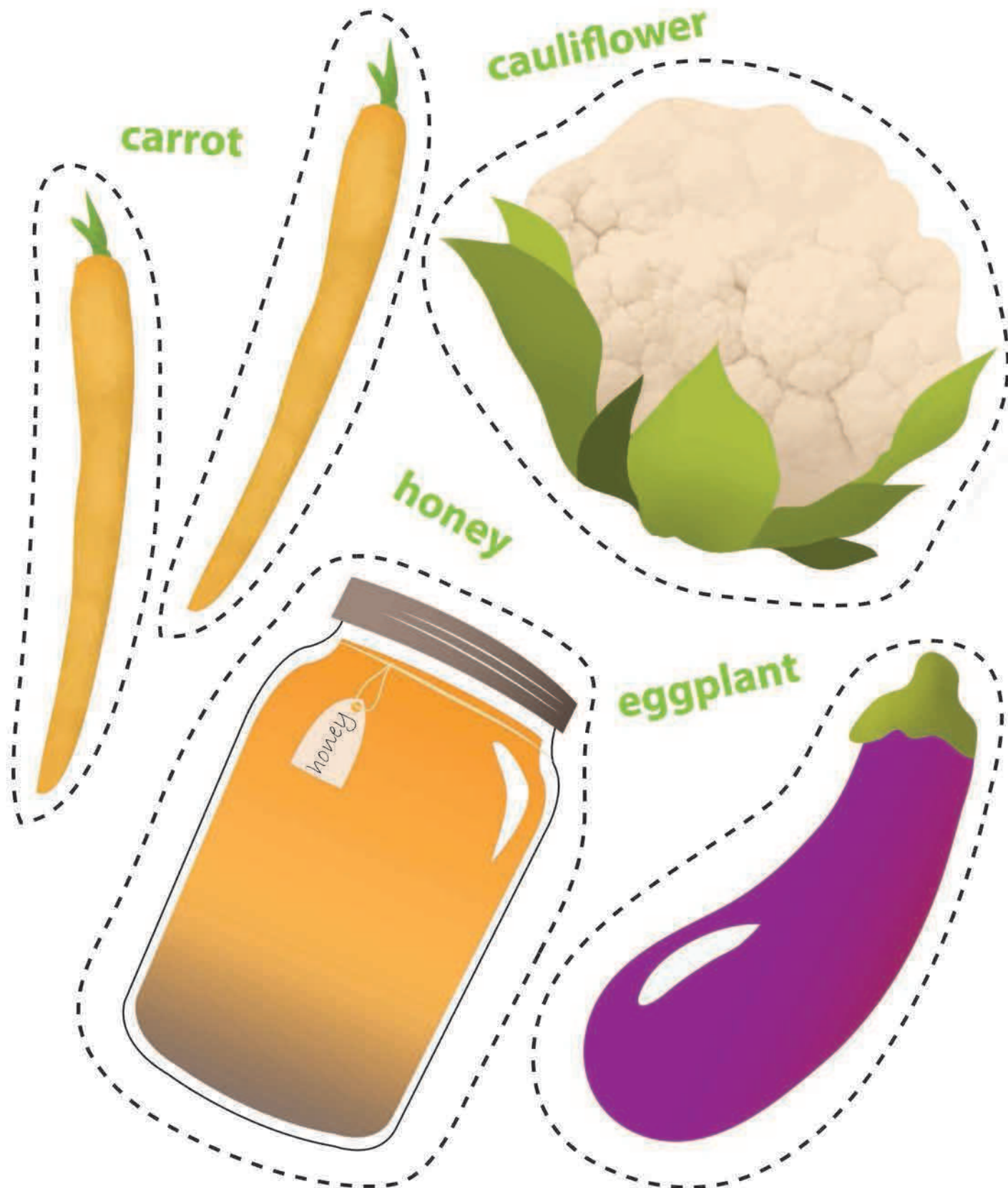

Cut and Play Farmers Market

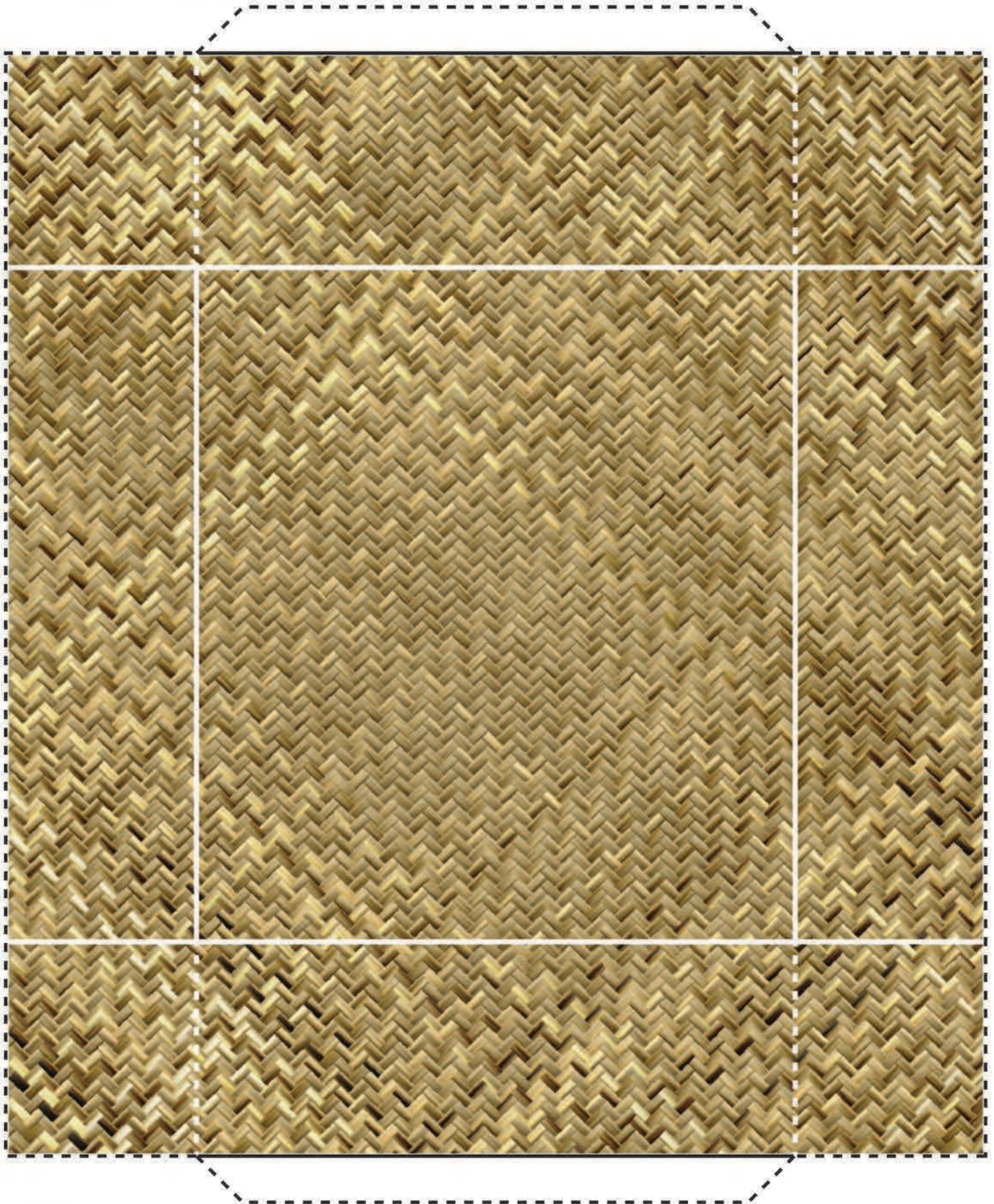

Cut and Play Farmers Market

Basket Craft Instructions

Step 1:

Cut out the basket template. Then, cut along the dotted lines at each corner.

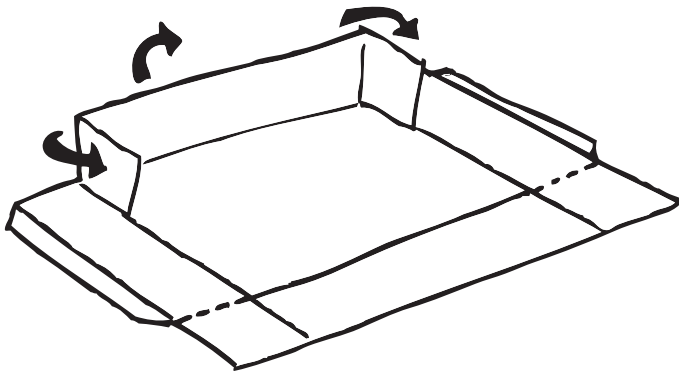
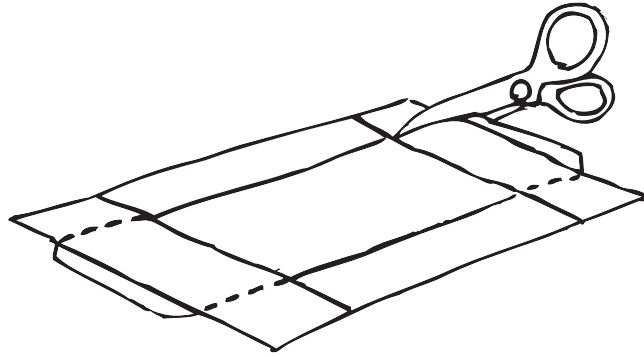

Step 2:

Fold in along the solid white lines. The blank side of the paper should be face-up.

Step 3:

Fold the white tabs on either end over on top of the previous folds. This will lock them all into place. You may want to use glue.

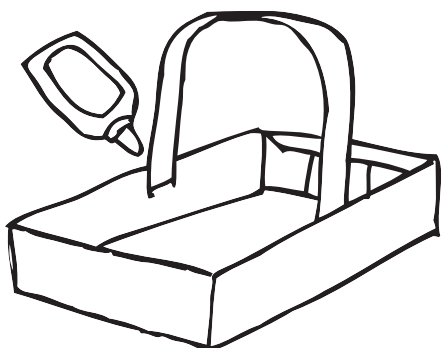
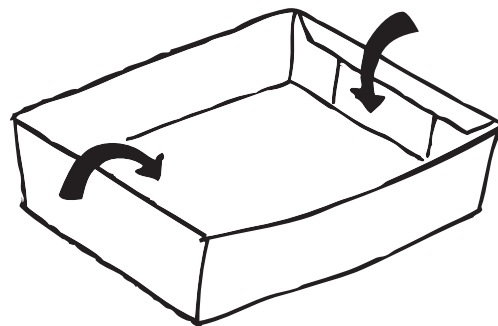

Step 4:

Cut out and glue the handle into the inside of the basket as shown.

HANDLE

Farmers Market Map

Directions: The farmers market has closed down the street for the day. Follow these steps to make your own market!

1. Cutout the market stands and fold them at the black lines.
2. Use glue to keep the tabs secure.
3. Use the following hints to put the stands in the right place on the street.

- The carrots are sold across from the apples.
- The lettuce is across from the cherries.
- The broccoli is right next to the lettuce.
- The apples are right next to the broccoli.

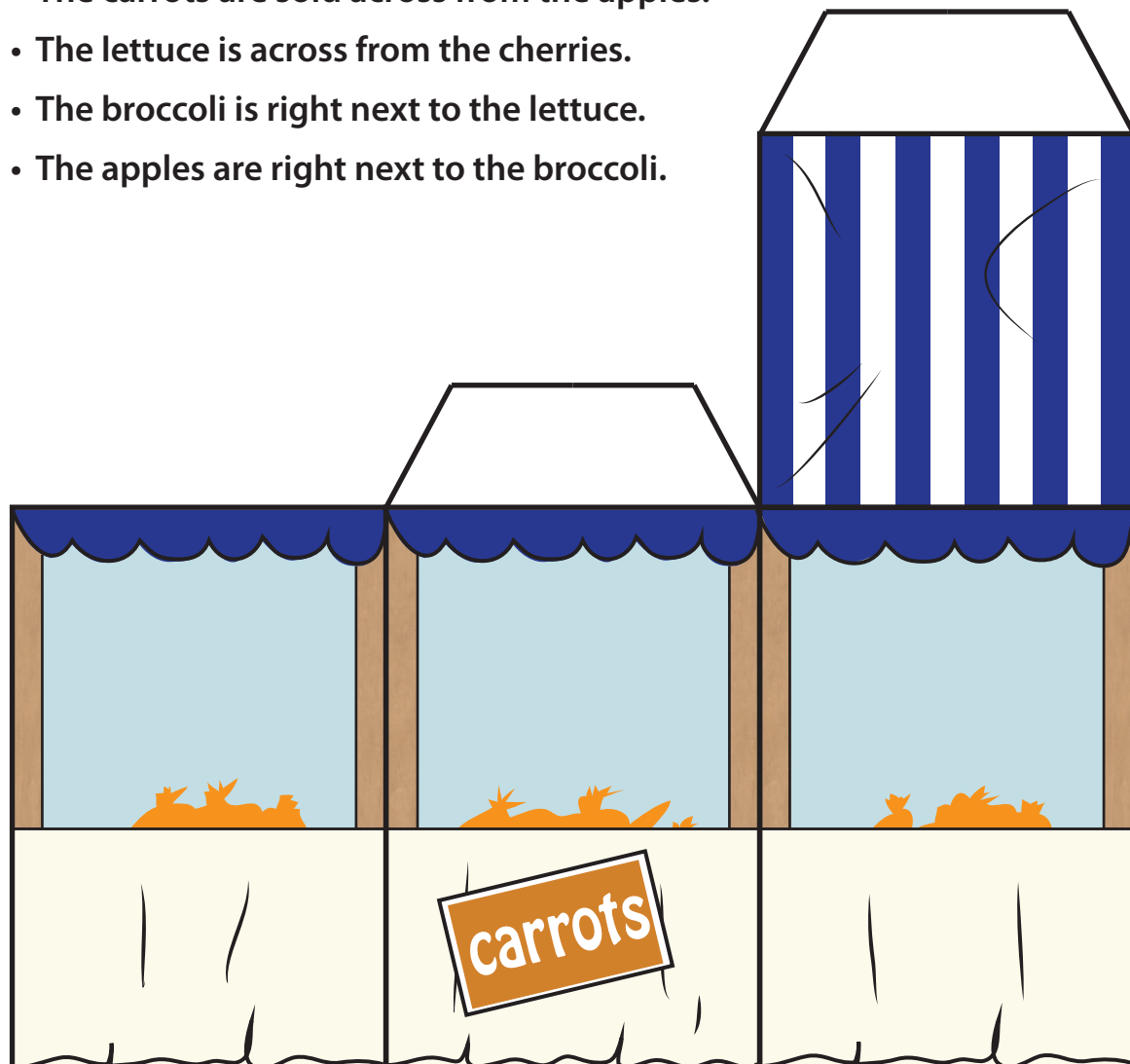

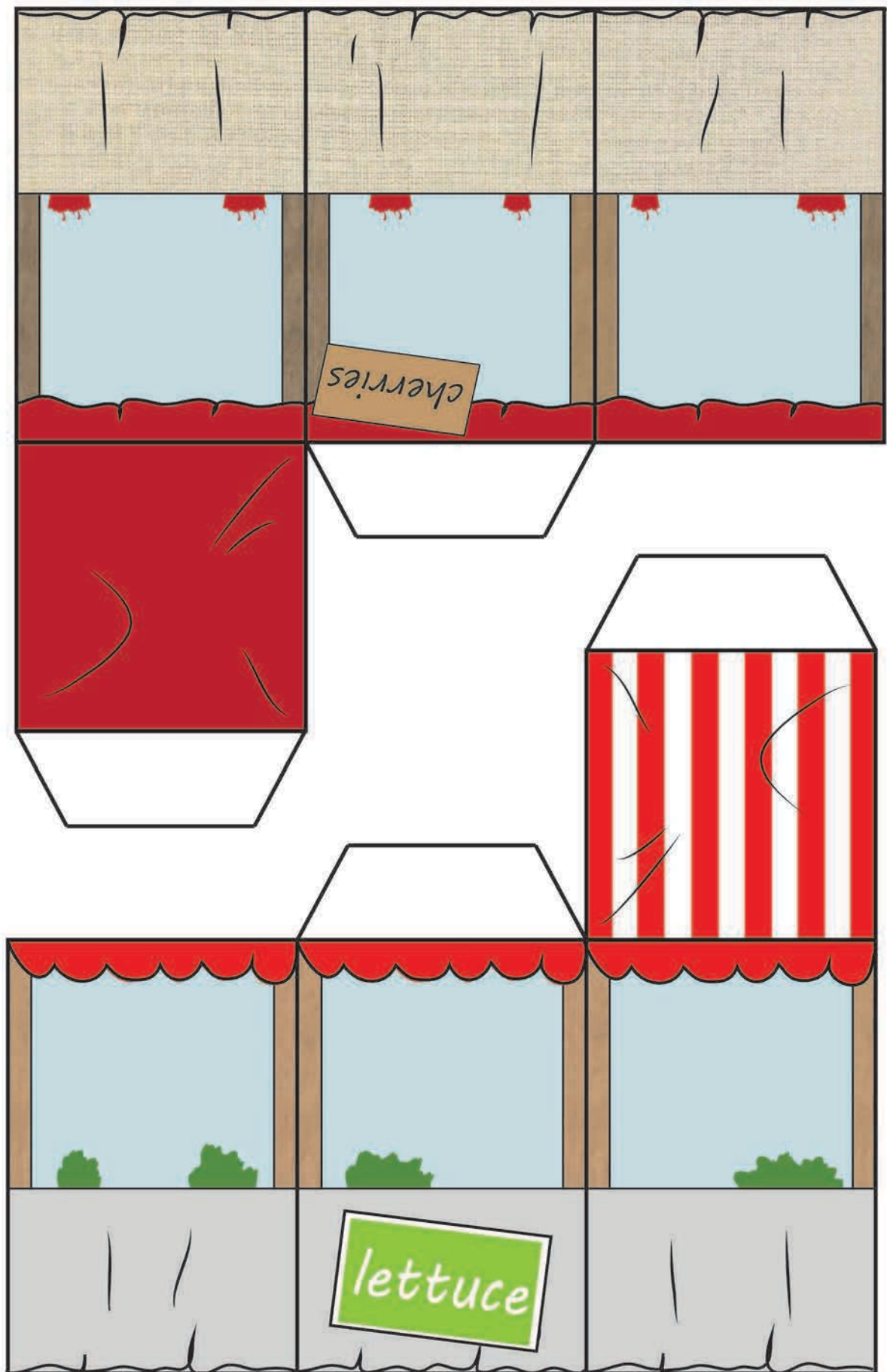

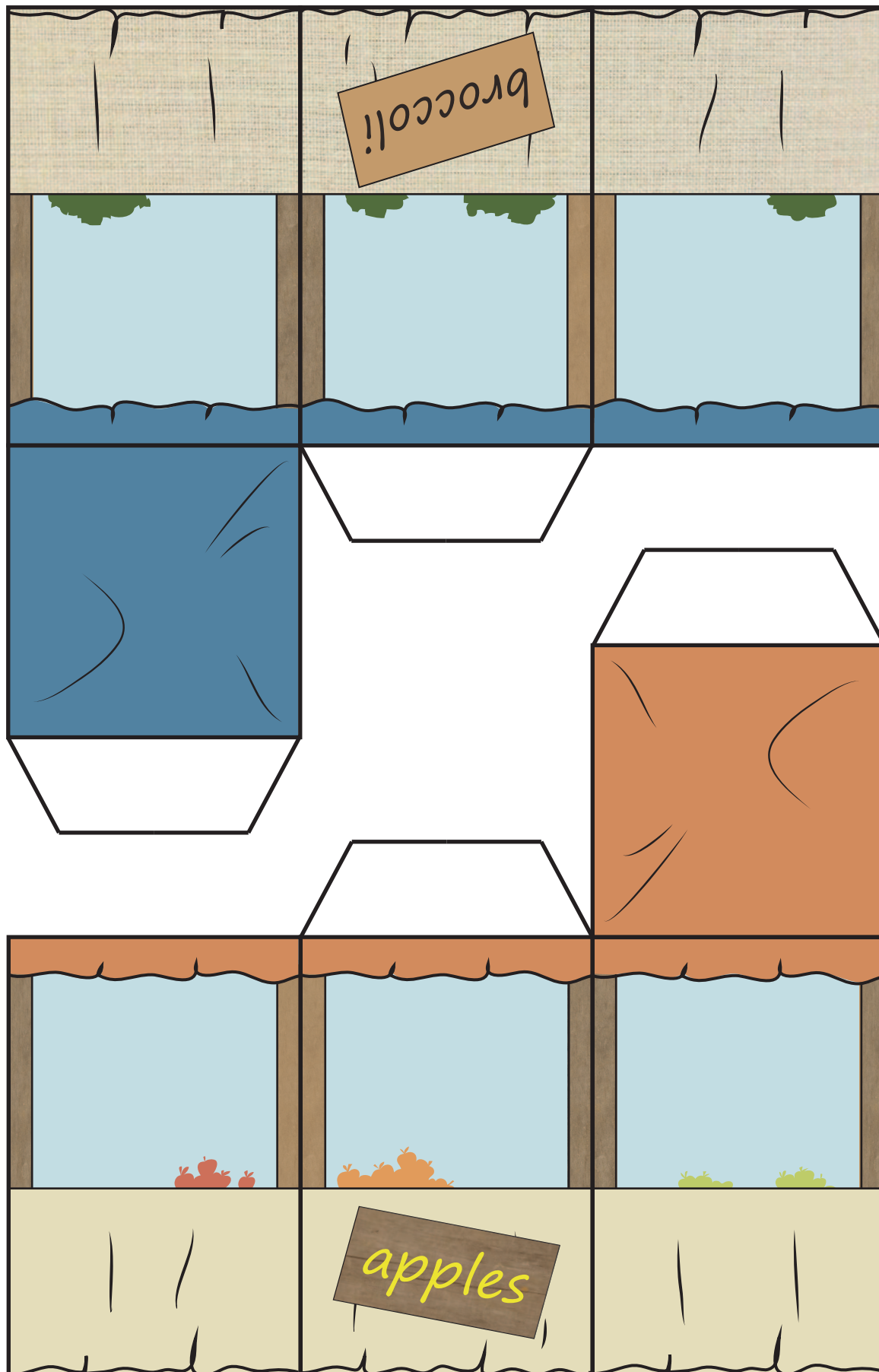



Matching Numbers to Quantity

Directions: Draw a line from the number on the left to its corresponding quantity of fruits or vegetables on the right.

one



two



three



four



five

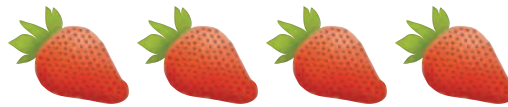

six



seven



eight



nine



ten



Matching Numbers to Quantity

Directions: Draw a line from the number on the left to its corresponding quantity of fruits or vegetables on the right.

1



2



3



4



5



6



7



8



9



10



Memory Match Game

Directions: Cut out all 20 cards and lay them face down. You must match the number card to its produce card, but only **2 cards** can be flipped over at any given time, until they have been properly matched.

ONE

TWO

THREE

FOUR

FIVE

SIX

SEVEN

EIGHT

NINE

TEN

Memory Match Game

Directions: Cut out all 20 cards and lay them face down. You must match the number card to its produce card, but only **2 cards** can be flipped over at any given time, until they have been properly matched.

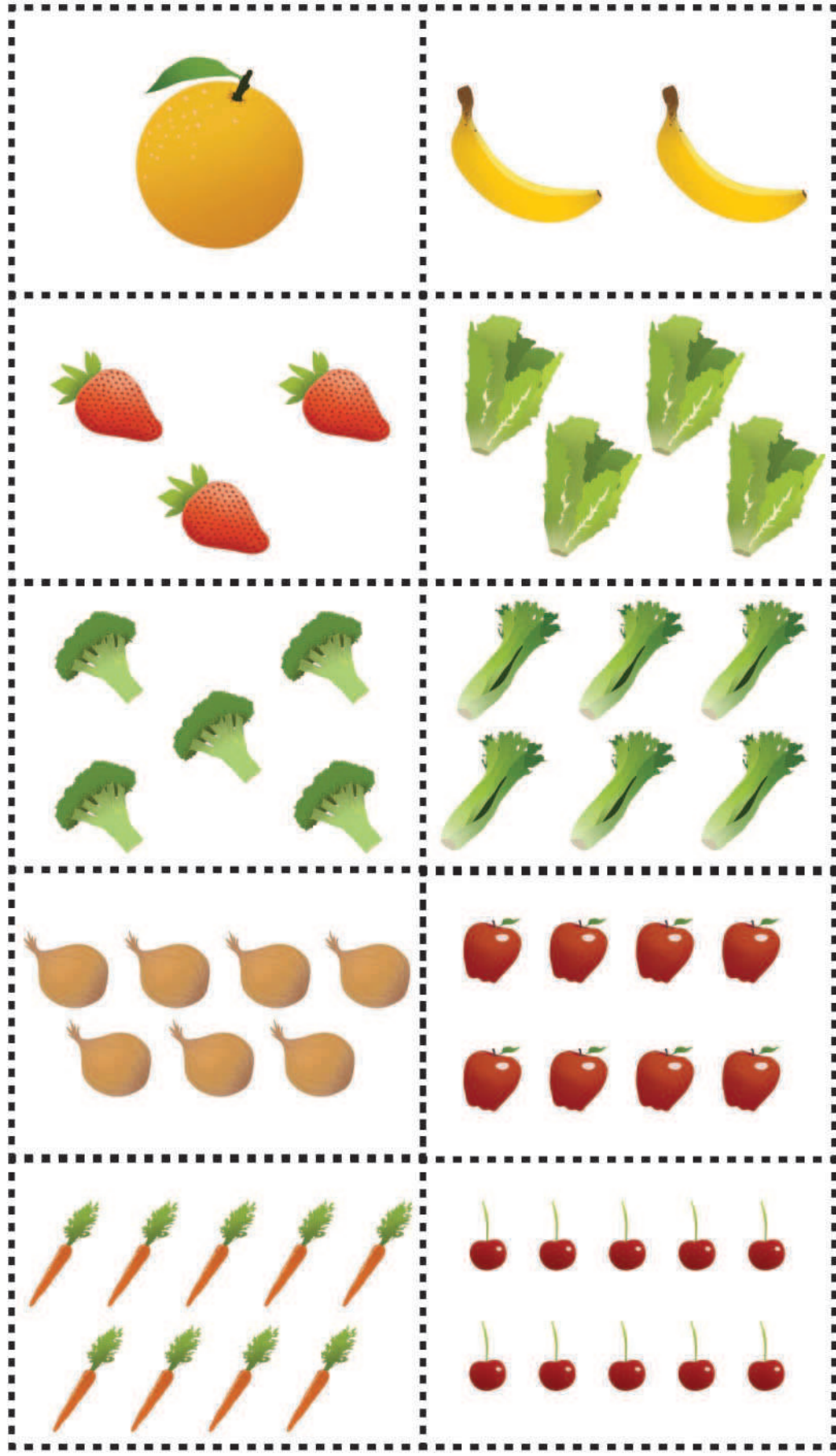

START



Cherry sale! Advance 2 spaces.

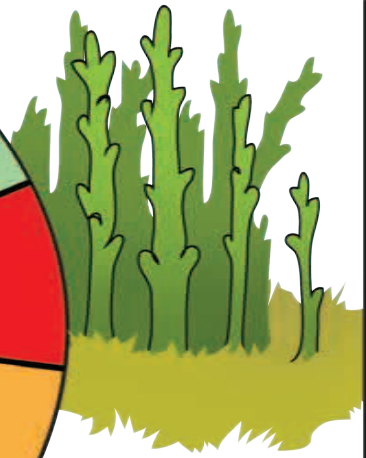
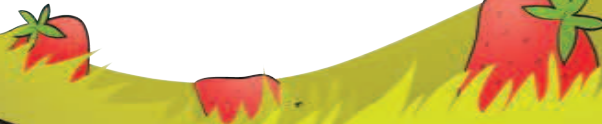

?

Didn't eat your veggies, lose a turn.

Number cards here.

?

You found the strawberry booth right away!
Advance 3 spaces.

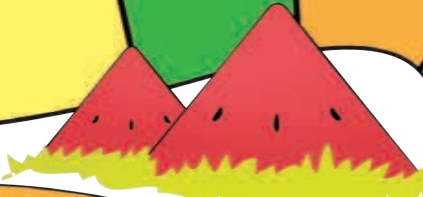

?

Too much candy, go back 2 spaces.

FINISH

You've reached the farmers market!

?

You dropped your oranges!
Lose a turn.

Number Cards

1

2

3

4

5

1

2

3

4

5

1

2

3

4

5

1

2

3

4

5

1

2

3

4

5

1

2

3

4

5

Fruit and Veggie Board Game

Set Up: Cut out the number cards and stack them face down on the spot indicated on the board. Cut out the fruit and veggie game pieces.

Directions: Each player must pick a vegetable or fruit game piece. Place your game piece at the start sign. To determine the order of turns, go youngest to oldest.

The first player picks a card from the stack. If the card says **2**, then the player must move forward 2 spaces. Then it's the next player's turn.  spaces mean there's a special condition for the spot you landed on. The first player to reach the farmers market wins!

Game Pieces



Market Graphing

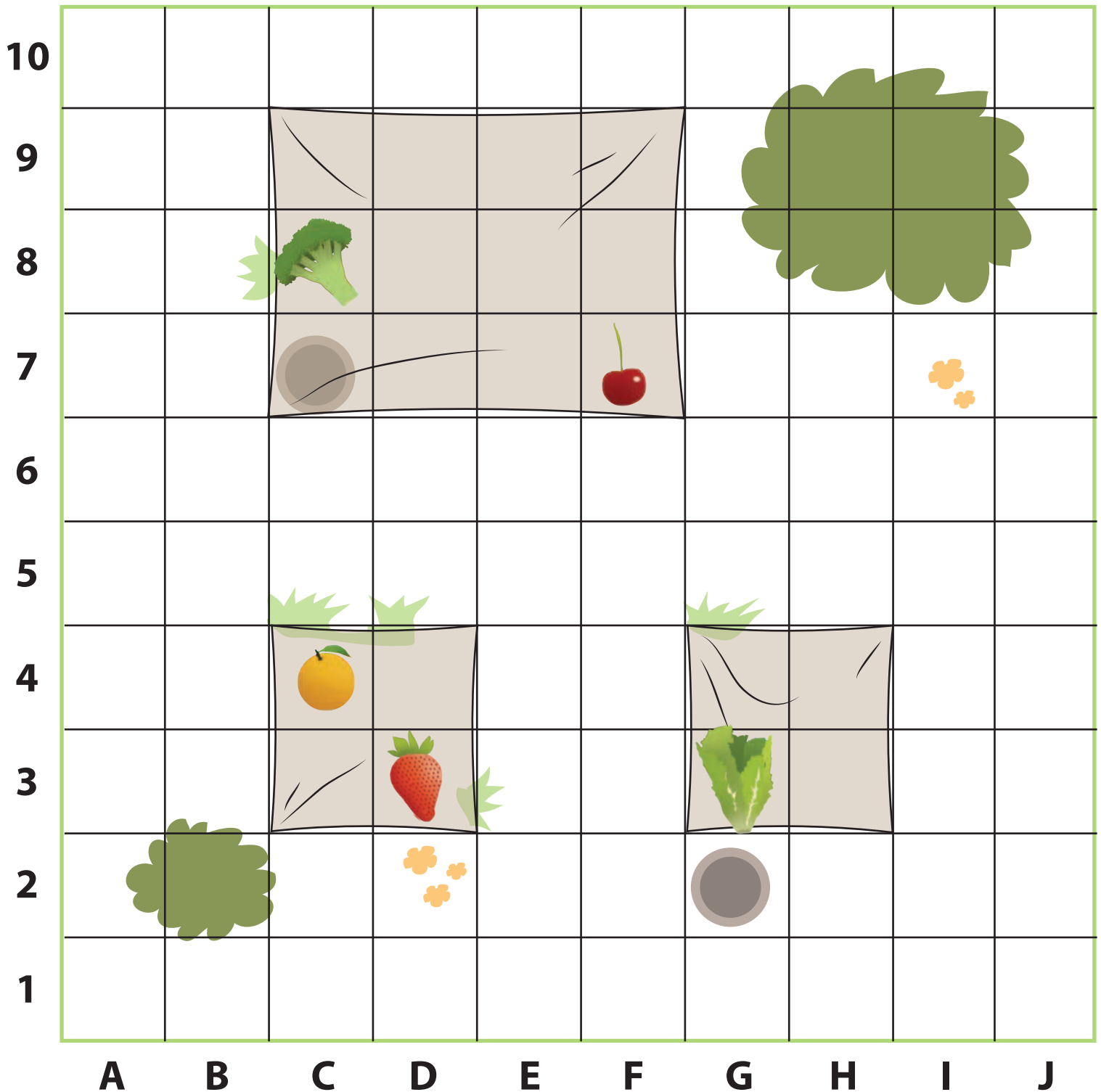

1. Where are the cherries being sold?
2. Where is broccoli being sold?
3. How far are the oranges from the broccoli?
4. How far are the strawberries from the lettuce?

Market Graphing 2

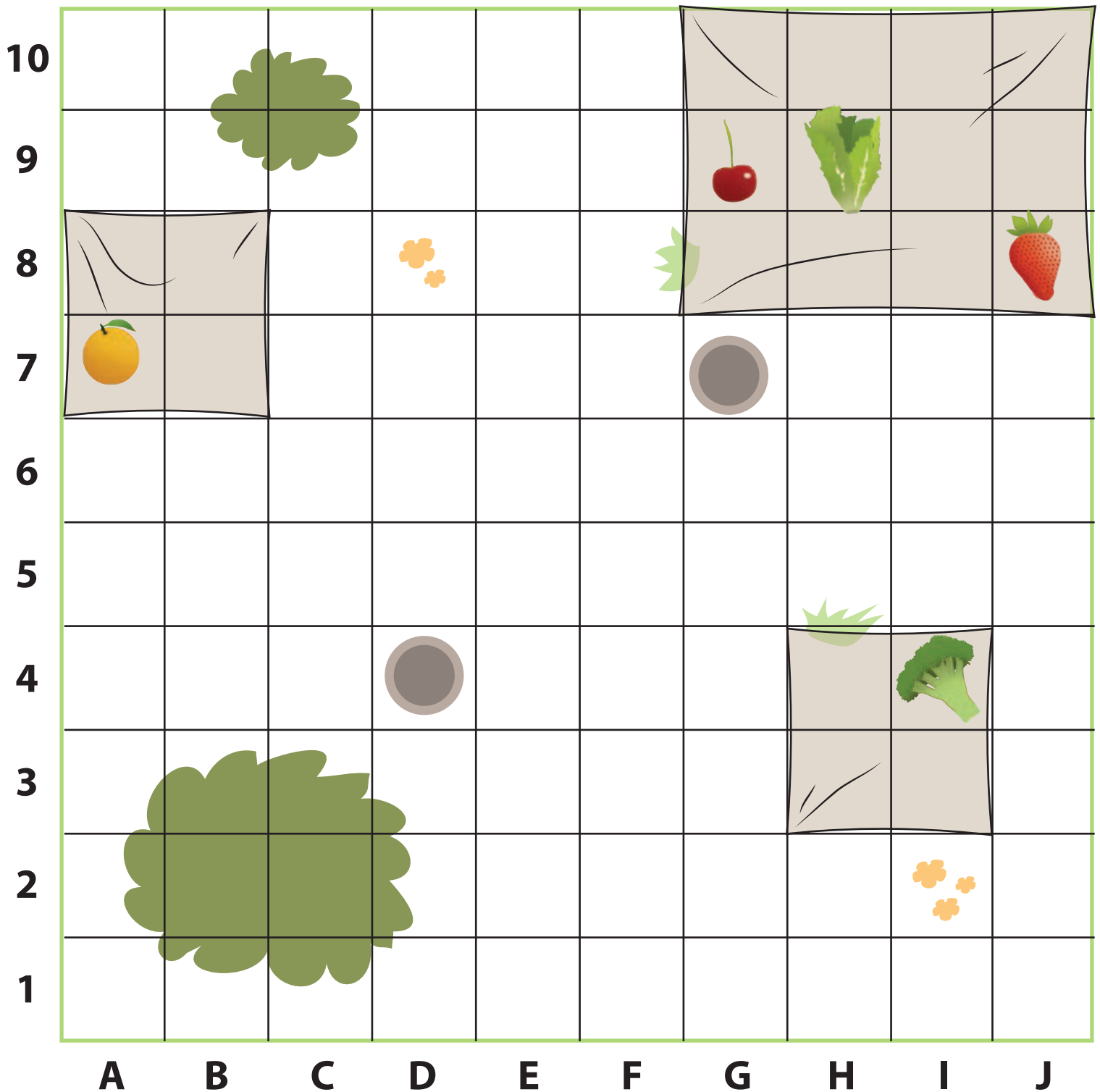

1. What can you buy at **A7**?
2. What can you purchase at **J8**?
3. What is being sold at **H9**?
4. What's being sold at **G9**?

Help the Farmer



Type of Vegetable	Tally Mark	Number
Apple		
Banana		
Broccoli		
Carrot		
Cherry		
Orange		
Strawberry		

1. What vegetable or fruit are there the least of?
2. What vegetable or fruit are there the most of?
3. How many vegetables and fruit are there all together?

Fact Families

Directions: Addition and subtraction are related! That means they use the same numbers, but in different ways. Count up each picture equation. Fill in the blanks to show the equations with numbers. What do you notice?

1

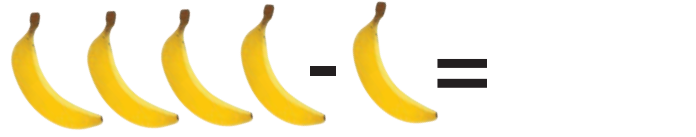
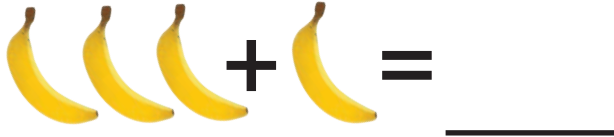

$\underline{\hspace{2cm}} + \underline{\hspace{2cm}} = \underline{\hspace{2cm}}$

$\underline{\hspace{2cm}} - \underline{\hspace{2cm}} = \underline{\hspace{2cm}}$

2



$\underline{\hspace{2cm}} + \underline{\hspace{2cm}} = \underline{\hspace{2cm}}$

$\underline{\hspace{2cm}} - \underline{\hspace{2cm}} = \underline{\hspace{2cm}}$

3

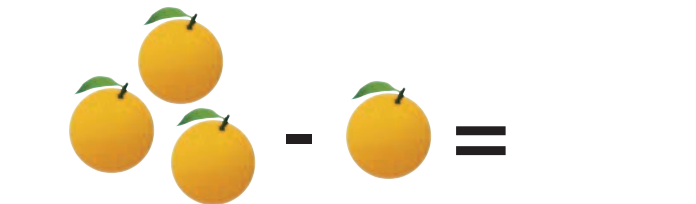
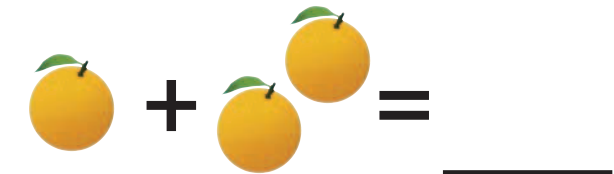

$\underline{\hspace{2cm}} + \underline{\hspace{2cm}} = \underline{\hspace{2cm}}$

$\underline{\hspace{2cm}} - \underline{\hspace{2cm}} = \underline{\hspace{2cm}}$

4

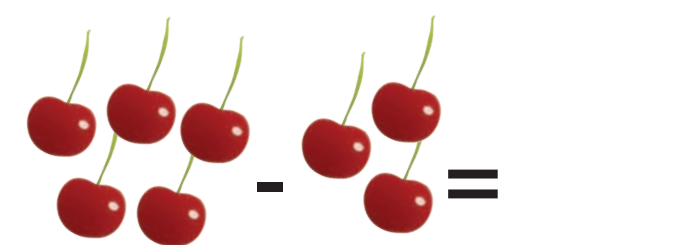
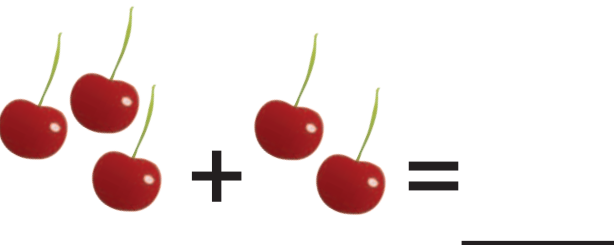

$\underline{\hspace{2cm}} + \underline{\hspace{2cm}} = \underline{\hspace{2cm}}$

$\underline{\hspace{2cm}} - \underline{\hspace{2cm}} = \underline{\hspace{2cm}}$

Using Money

Directions: It is your job to buy the groceries for your family. Figure out all the different ways you can pay for each item.



1 Bill went to the market with 33 ¢.
He bought three different vegetables.
He spent all of his money.
Which three vegetables did Bill buy?

2 Sarah needs to buy lettuce.
Sarah has 10 pennies and 2 nickels.
What are the three ways Sarah can pay for the lettuce?

3 Tanya wants to buy two onions
She paid for the vegetables with 1 quarter.
What was her change from the purchase?

4 Greg wants to buy broccoli.
He has 1 dime, 2 nickels and 6 pennies.
How many different ways can Greg can pay for the broccoli?

5 Natalie has 50 cents.
She bought 1 onion, 3 carrots and 1 broccoli.
What was her change from the purchase?

6 Martha has 3 dimes, 1 quarter and 1 nickel.
She bought 3 lettuce.
What are the two ways Martha can pay for the 3 lettuce?

Using Money

Directions: Use these cut-out coins to solve the word problems!



Match Numbers and Words

Directions: Cut out all 20 cards. Match up each written number with its numerical symbol. Play a memory match game or use the cards as flashcards!

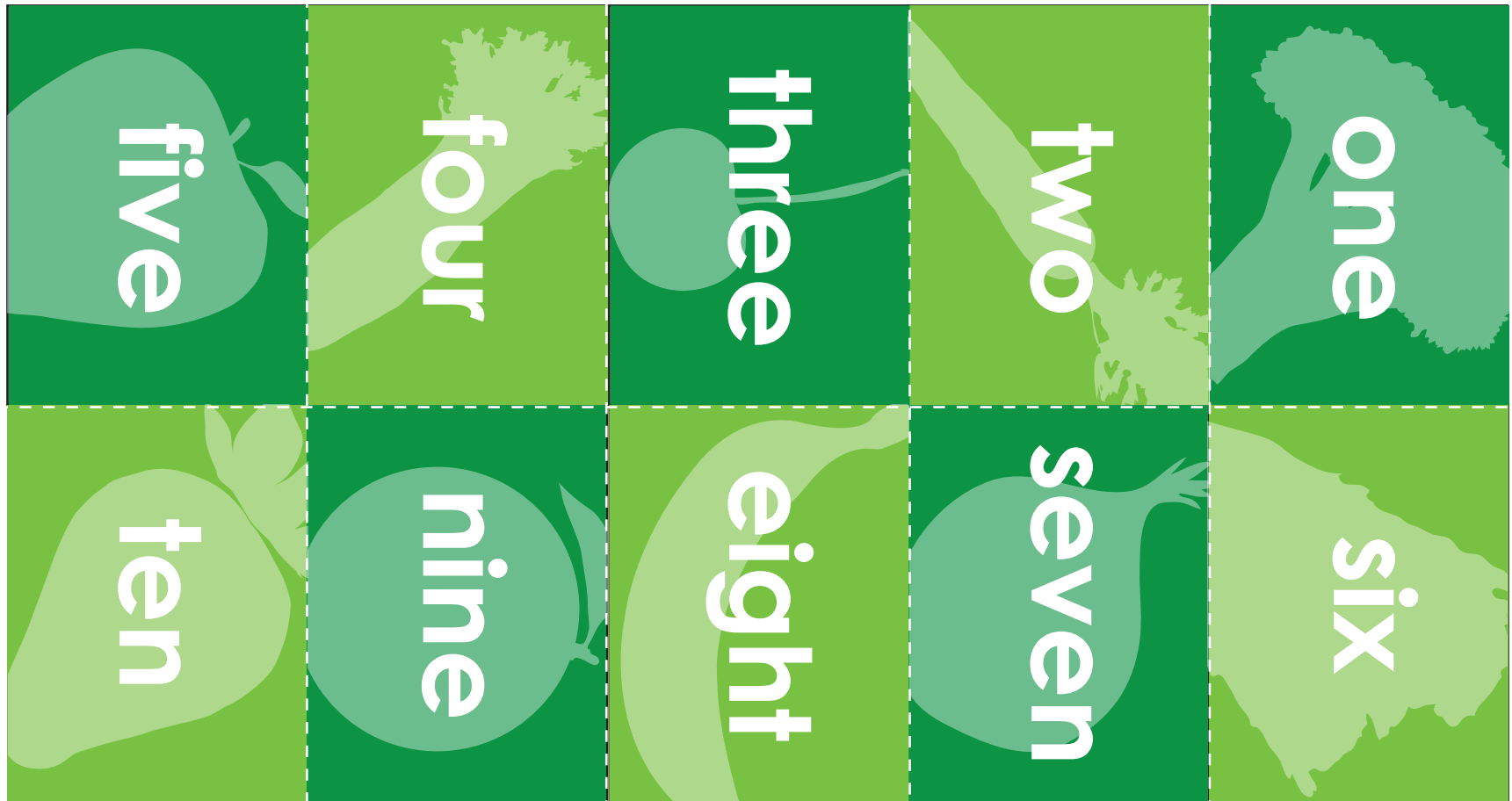

Match Numbers and Words

Directions: Cut out all 20 cards. Match up each written number with its numerical symbol. Play a memory match game or use the cards as flashcards!

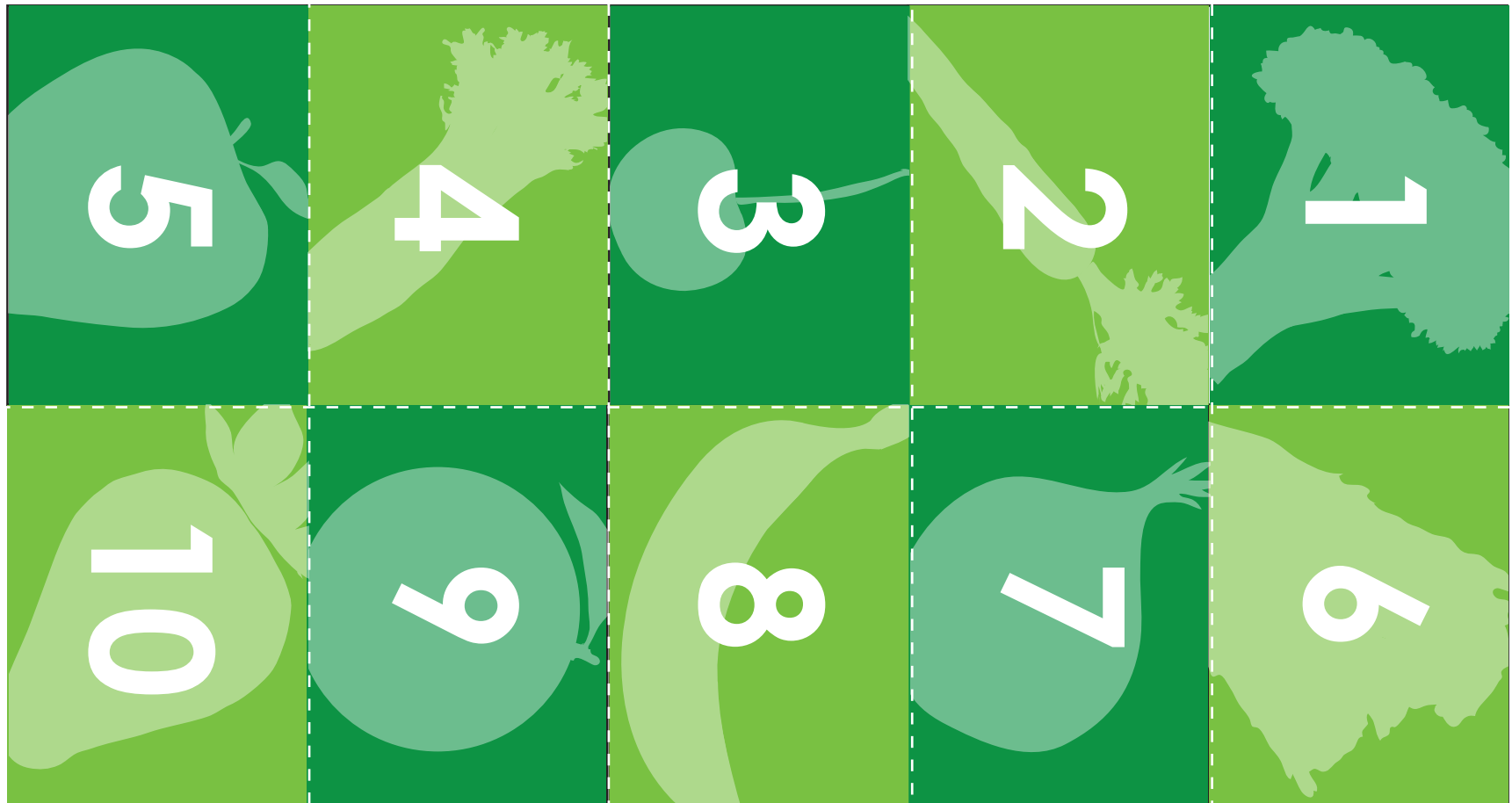

Addition and Subtraction

Directions: Can you solve these produce word problems? Try drawing pictures to help figure out what the answer is!



If you needed **3** apples for a pie and **4** apples for juice, how many apples do you need to buy?

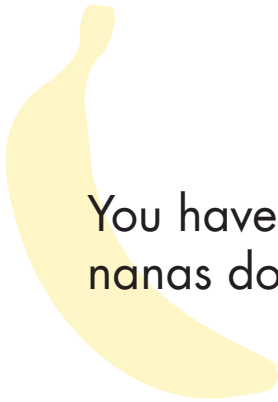

You have **2** bananas. You need **1** more. How many bananas do you need altogether?



If you were carrying **10** strawberries, and **3** fell on the ground, how many would you have left in your bag?

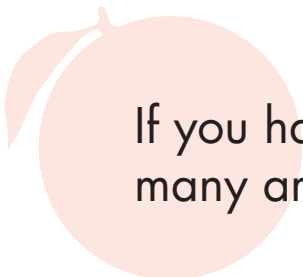

If you have **6** oranges and you decide to put **5** back, how many are you left with?

Market Riddles

Directions: Circle the correct produce by following the clues given.

It is red. It has small, seed-like objects on its surface called achenes. Its stem has green petals.



It is round. It has tough outer skin. It is orange.



It has a core. It can be red, green or yellow. It is used to make cider.

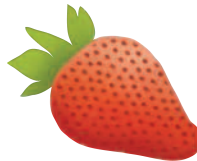

It is small. It is round. It has one seed at its core.



It is long and slender. It is yellow when ripe. You peel its skin to eat it.



Market Riddles 2

Directions: Circle the correct produce by following the clues given.

It is not big. It is not perfectly round. It does not have a smooth surface.

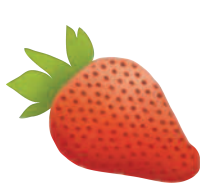

It is not round. It is not red. It is not very juicy.



It is not small. It is not orange. It does not have only 1 seed.



It is not red. It is not elongated. It does not have a core.



It is not orange. It does not have seeds on its surface.
It does not have a tough outer skin.



Great job!

is an Education.com math superstar

